

STRANGE 1.0

INSTALLATION INSTRUCTIONS | JULY 2024

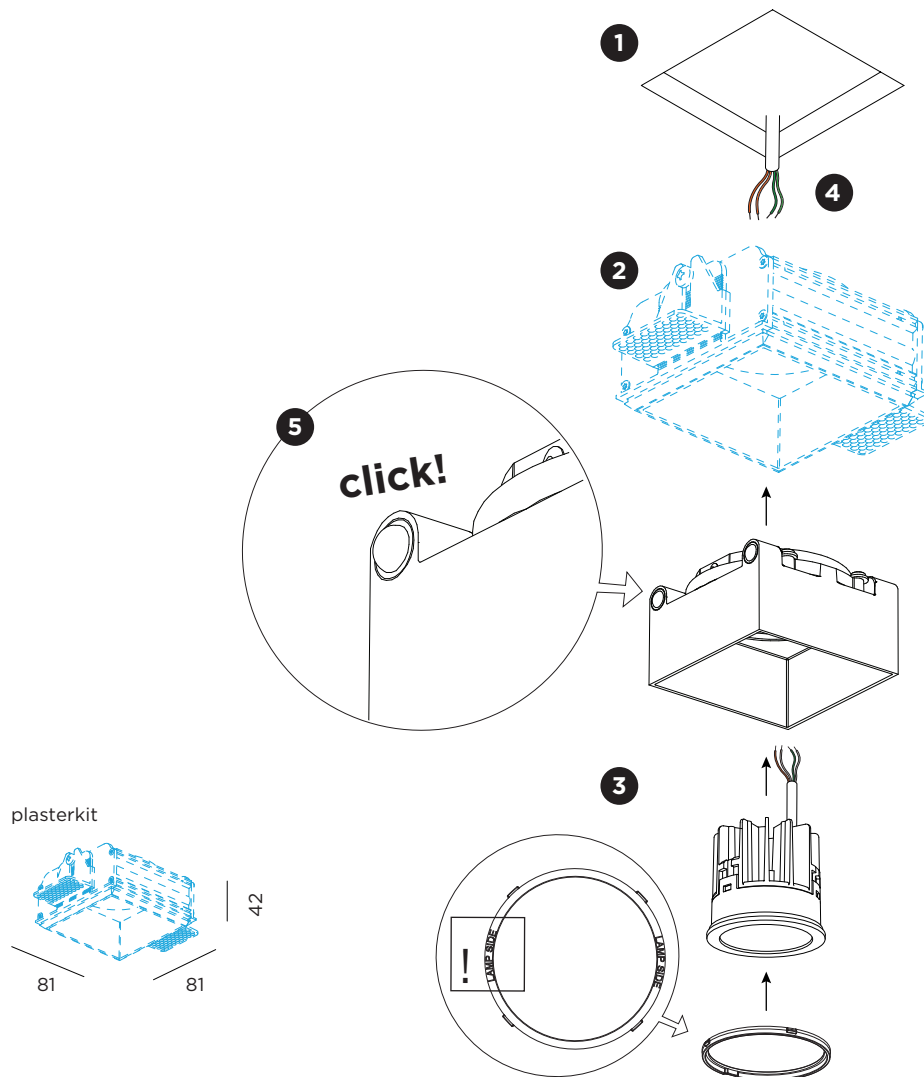

DIMENSIONS

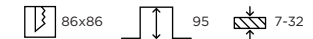
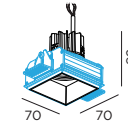

1.0 LOXONE

MOUNTING INSTRUCTION

- 1 Make a hole in the ceiling according to the prescribed dimensions (always use a plasterkit).
 - 2 Mount the plasterkit into the ceiling and screw it tightly on the ceiling, then plaster the borders seamlessly (screws are not included).
- See separate installation instruction of the plasterkit.
- 3 Put the LED module in the assembly set and fix it with the spring clip.
 - 4 **POWER CONNECTION**
Connect the wires to the connectors.
Input voltage 20-28V.

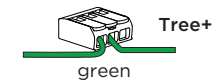

- 5 Click the fixture into the plasterkit.

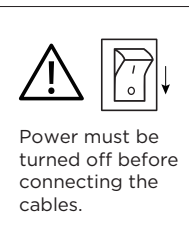

This fixture only works with Loxone TREE.



STRANGE 1.0

INSTALLATION INSTRUCTIONS | JULY 2024

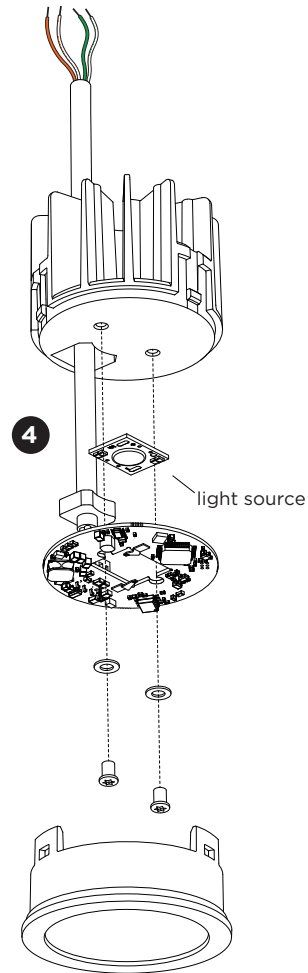
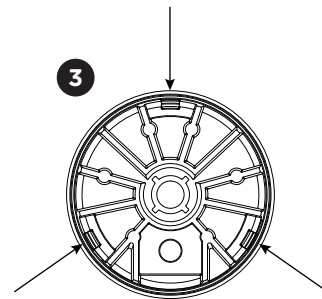
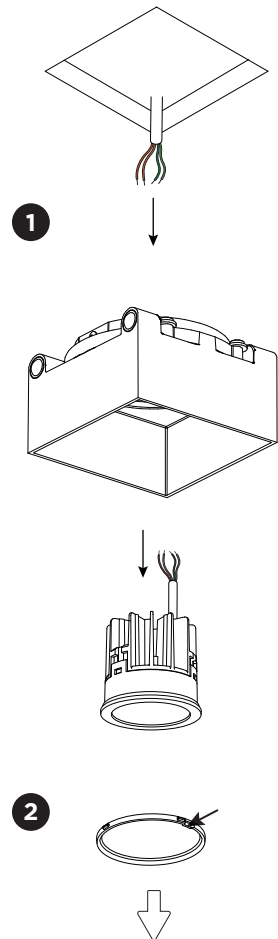

DISMOUNTING AND RECYCLING INSTRUCTIONS

Light source

- 1 Remove the fixture from the ceiling and disconnect the wires.
- 2 Push in the slot of the spring clip and pull it down to remove the LED module.
- 3 Push at the three points to loosen the front ring.
- 4 Unscrew the light source to remove it.

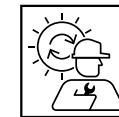

The light source is replaceable by Wever & Ducré or by a professional with explicit authorisation. For more information please contact your local Wever & Ducré customer service point.



This luminaire contains a light source with the energy class F.



WEVER & DUCRÉ
LIGHTING

WEVER & DUCRÉ BV

Spinnerijstraat 99/21, 8500 Kortrijk, Belgium
weverducre.com